

ITM. / ART. 1435196

MFR# 9S200U5

Fabric Sectional with Storage Ottoman

Ensemble modulaire en tissu avec pouf de rangement

Sofá seccional de tela con otomano para almacenamiento



Assembly Instructions

Instructions d'assemblage

Instrucciones de ensamble

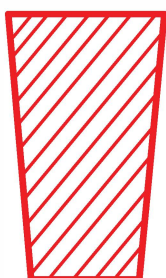

IMPORTANT, RETAIN FOR FUTURE REFERENCE: READ CAREFULLY
For more information, visit: www.northridge-home.com

IMPORTANT, À CONSERVER POUR DE FUTURS BESOINS
DE RÉFÉRENCE : À LIRE SOIGNEUSEMENT
Pour en savoir plus, visiter le www.northridge-home.com



IMPORTANTE: CONSERVE PARA FUTURA REFERENCIA. LEA
CUIDADOSAMENTE
Para más información, visite: www.northridge-home.com

For parts or customer service call: **1-866-387-8065**

Or email: info@northridge-home.com

(English, French and Spanish languages spoken)

Monday-Friday 8am - 8pm (EST).

Telephone number is only valid in the United States and Canada.

Pièces et service à la clientèle : **1-866-387-8065**

Courriel : info@northridge-home.com

(Anglais, français et espagnol)

Du lundi au vendredi : de 8 h à 20 h (HNE).

Ce numéro de téléphone n'est valide qu'aux États-Unis et au Canada.

Para solicitar piezas o hablar con un representante
de atención al cliente, llame al **1-866-387-8065**

Correo electrónico: info@northridge-home.com

(Atención en español, inglés y francés)

De lunes a viernes, de 8am - 8pm., hora del este.

El número es válido solamente en los Estados Unidos y Canadá.

Telefono no válido en Mexico.

WARNING: Small parts choking hazard

AVERTISSEMENT : Risque d'étouffement – Comprend de petites pièces

ADVERTENCIA: Piezas pequeñas. Riesgo de asfixia.

Ax1 *

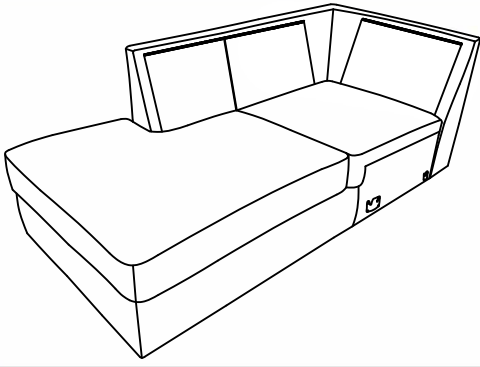

Bx 1*

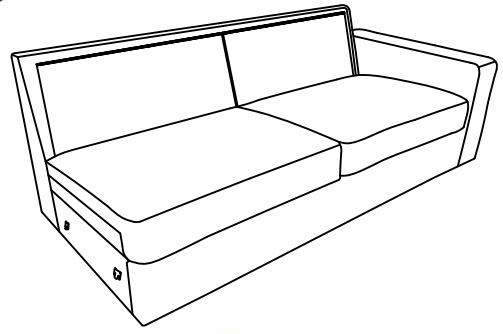

Cx 1*

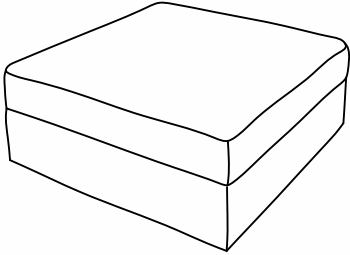

Dx 12*

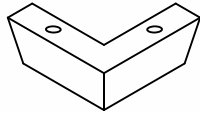

E x 2*



Fx 1*

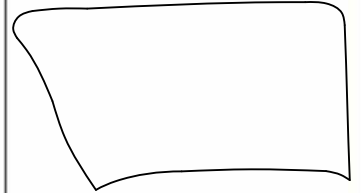

G x 2*

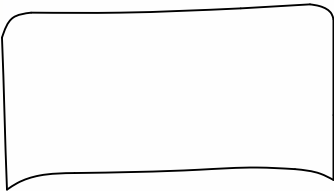

H x 1*

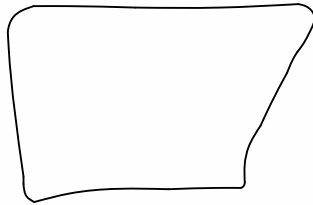

I x 1*

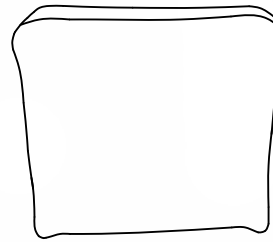

J x 24*

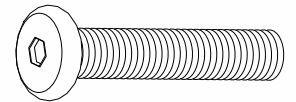

K x 24*

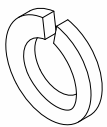

L x 24*

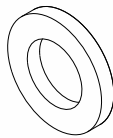

M x 1*



Caution

Do not allow children to play on this piece of furniture, or operate the mechanism. Leg rest folds down upon closing, possibly causing injury. Always leave in an upright and closed position and keep hands and feet clear of mechanism. Only the occupant should operate it.

Attention

Ne pas laisser d'enfants jouer sur le fauteuil ni utiliser son mécanisme. Le repose-pied se replie à la fermeture, ce qui représente un risque de blessure. Toujours laisser le fauteuil relevé et fermé. Ne pas insérer les mains ou les pieds dans le mécanisme. Seule la personne assise dans le fauteuil devrait utiliser le mécanisme.

Atención

No permita que niños jueguen en el sillón ni accionen el mecanismo. El reposapiés se dobla hacia abajo al cerrar, lo que puede causar lesiones. Siempre deje el sillón en posición vertical y cerrada. No acerque las manos ni los pies al mecanismo. El mecanismo debería ser activado solo por la persona sentada.

Touch-up Pen
Crayon de retouche
Pluma para retoques



1

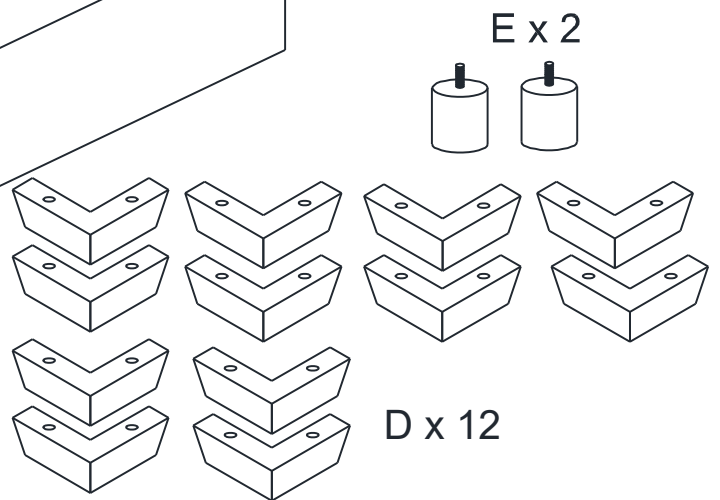
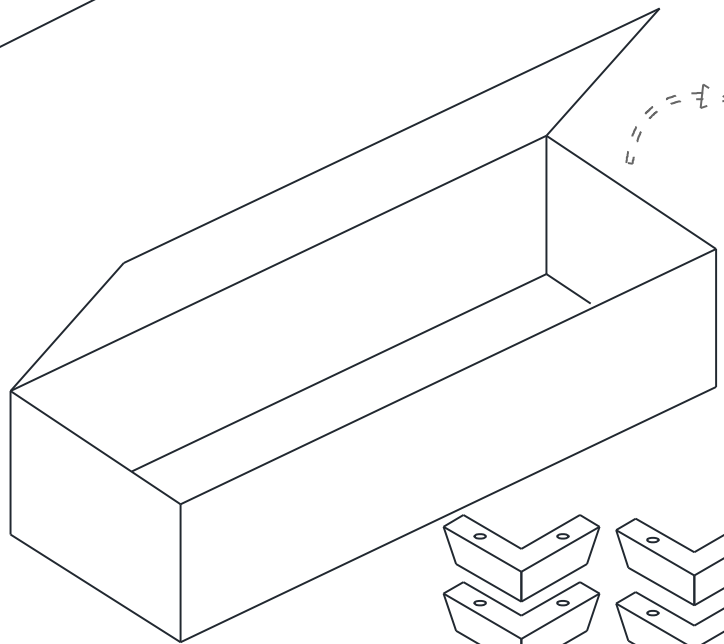
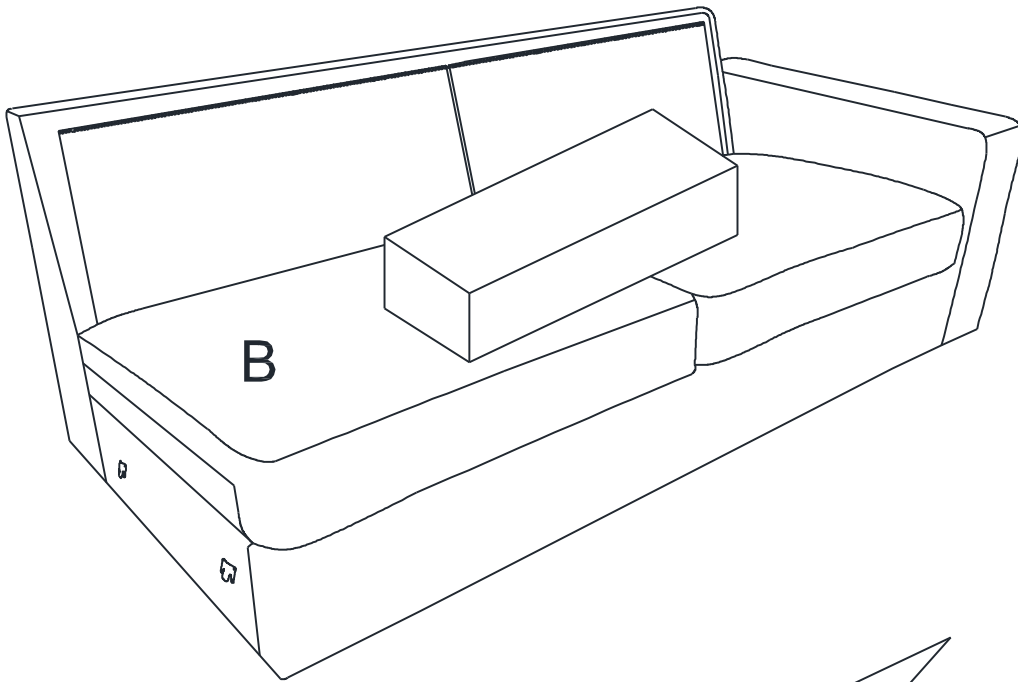

2

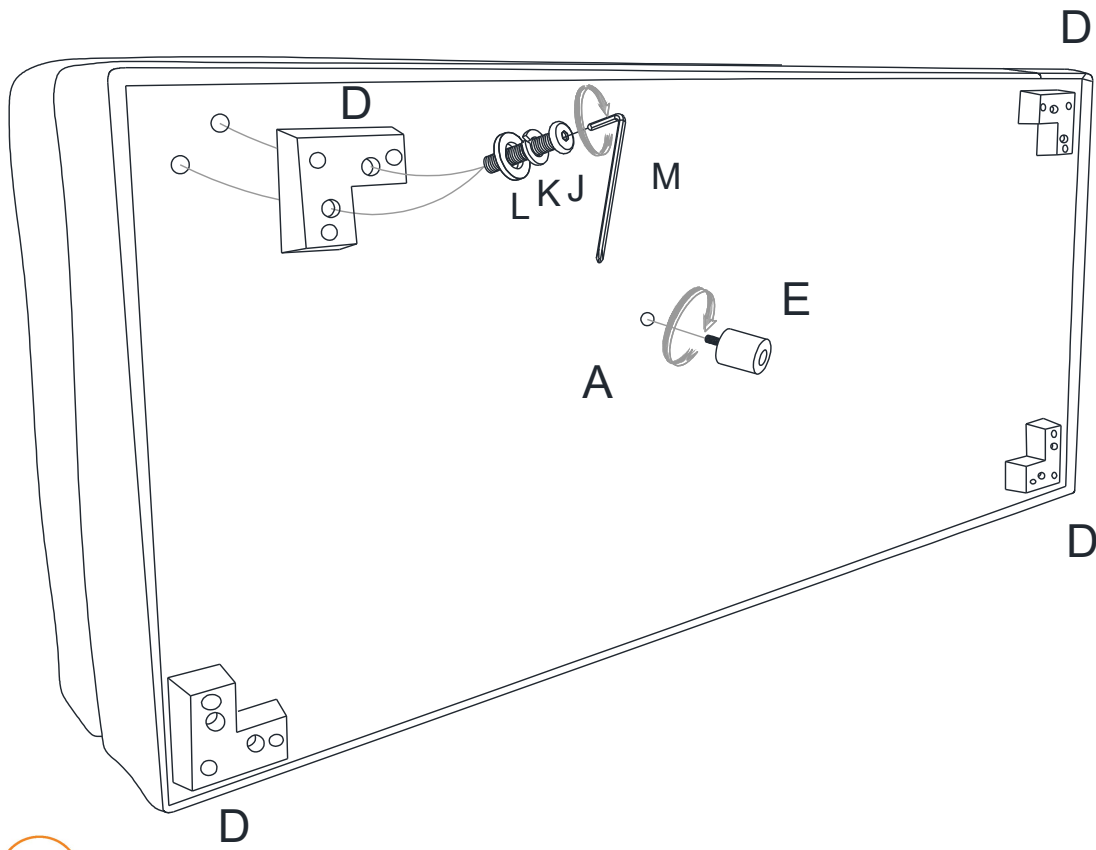

3

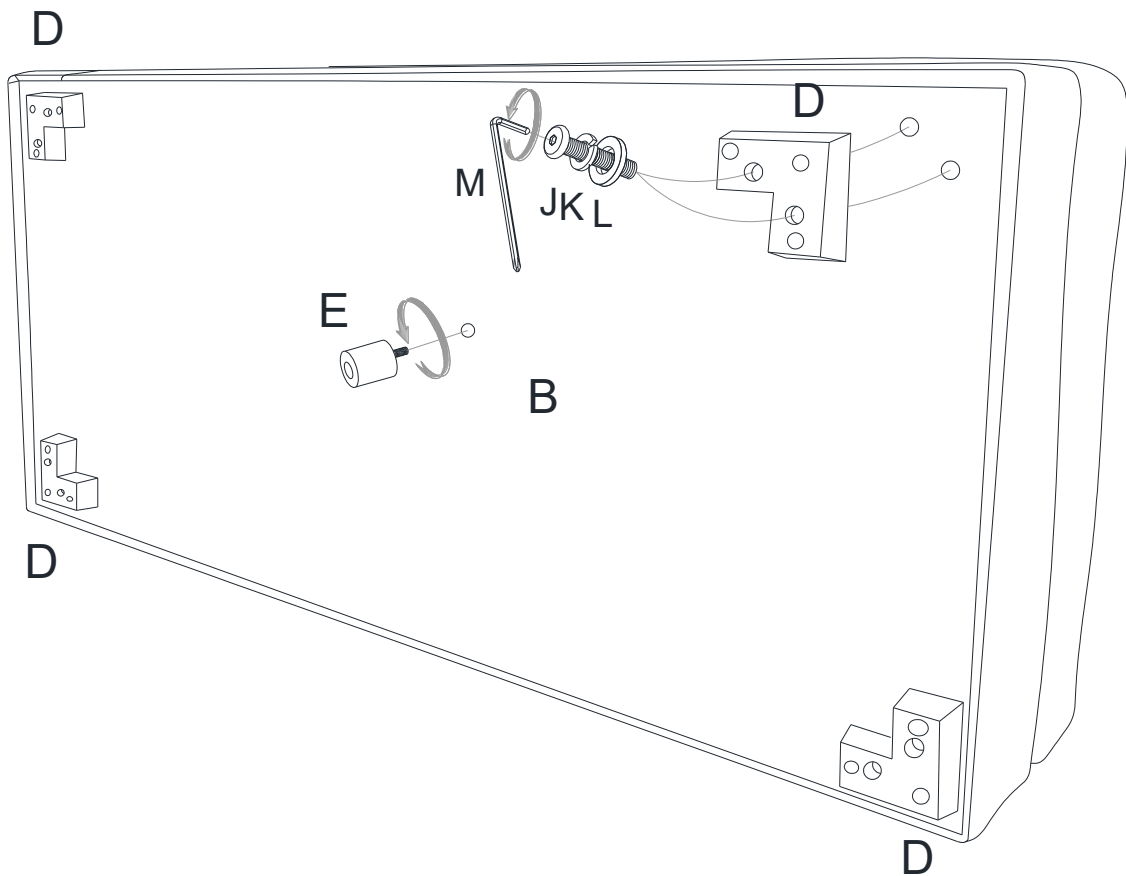

4

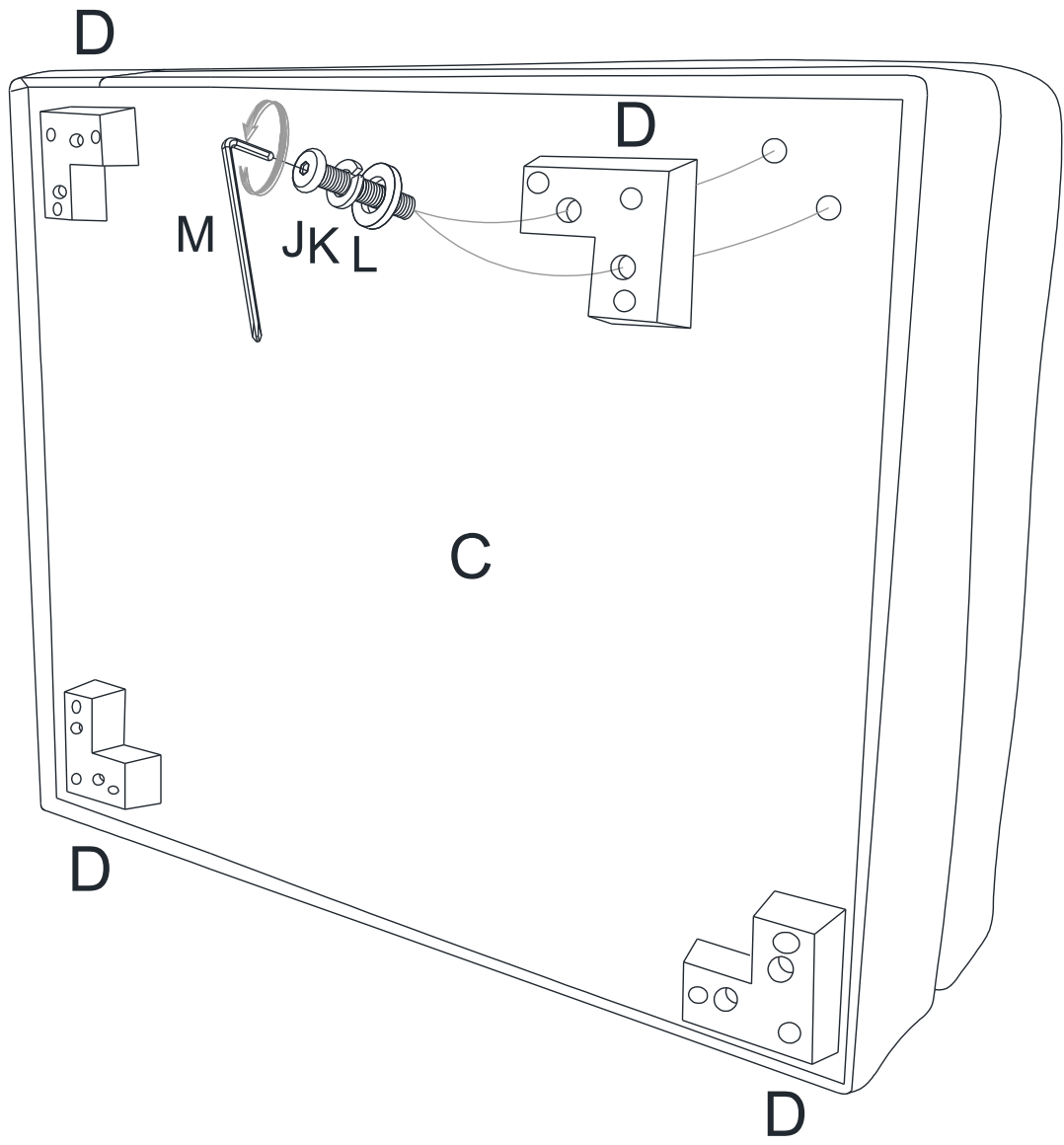

5

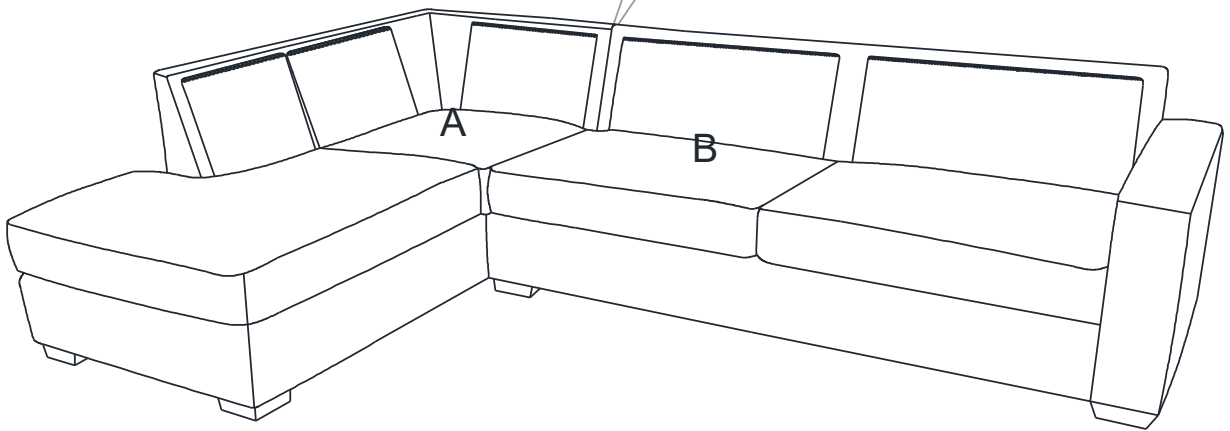
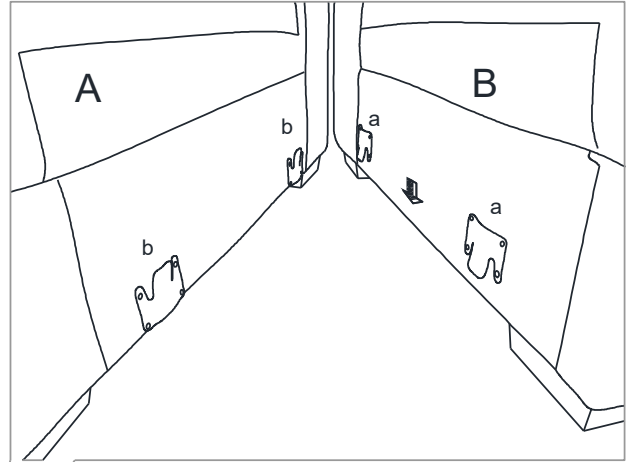
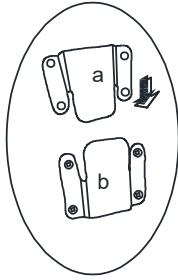
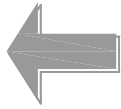
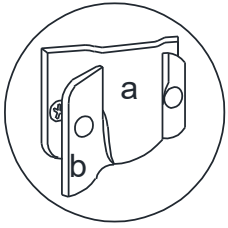

6

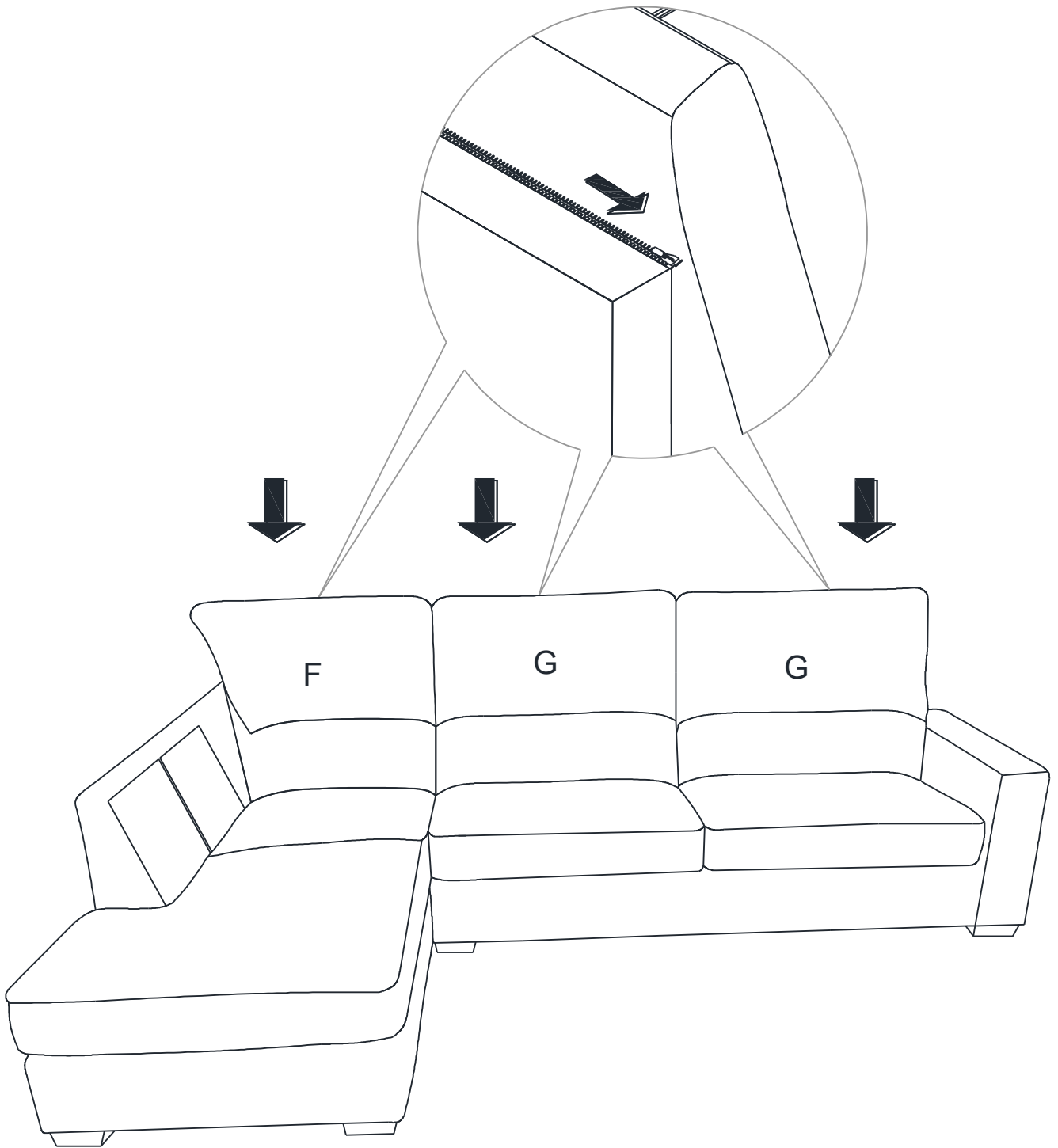

7

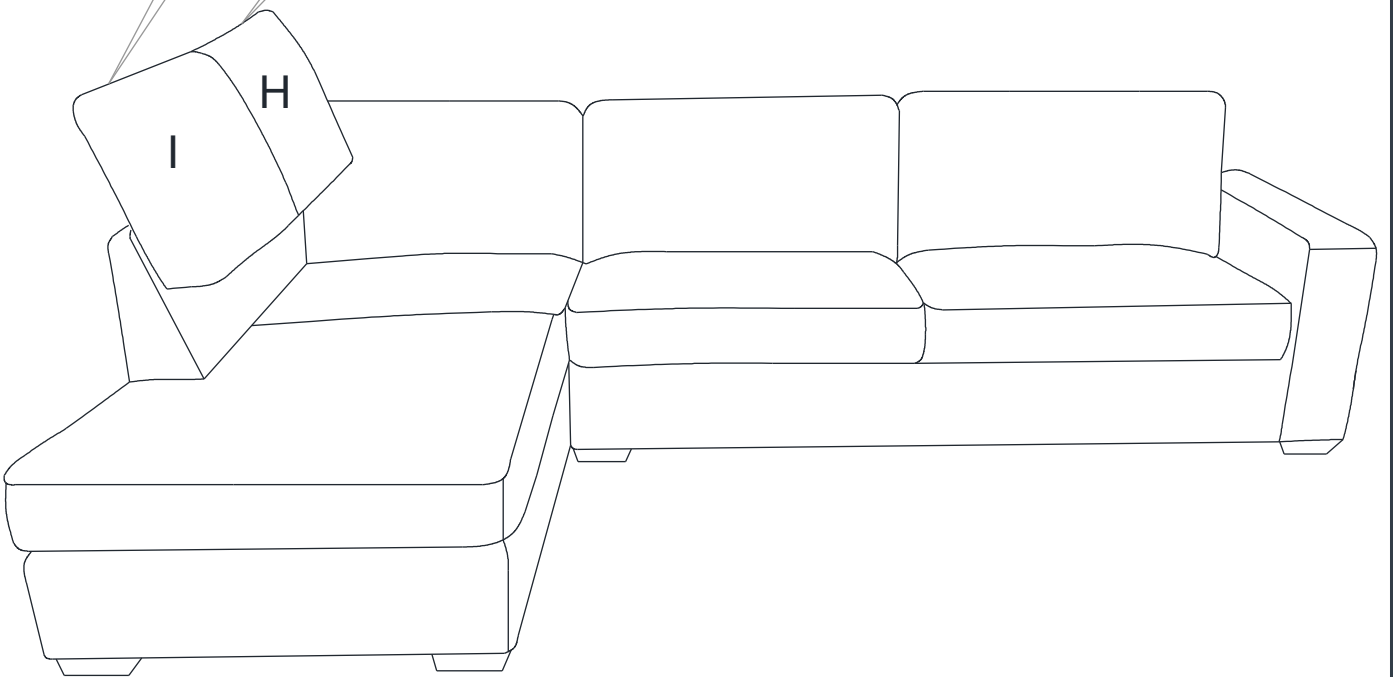
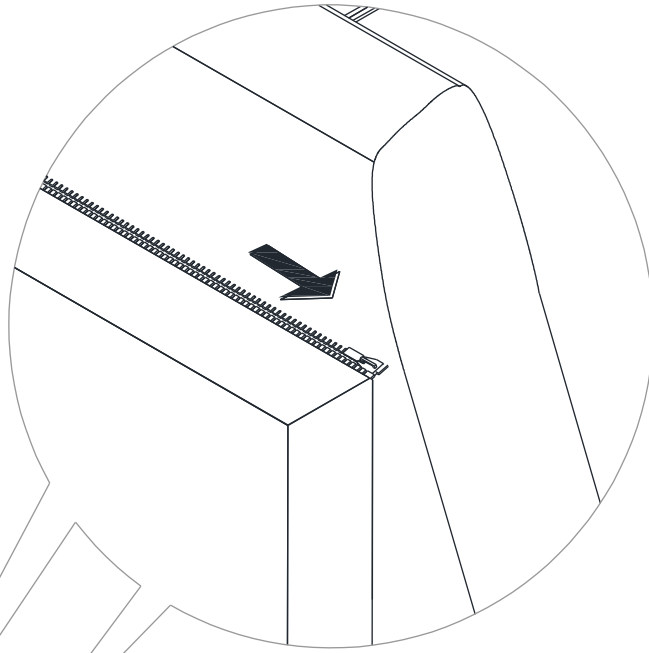

8

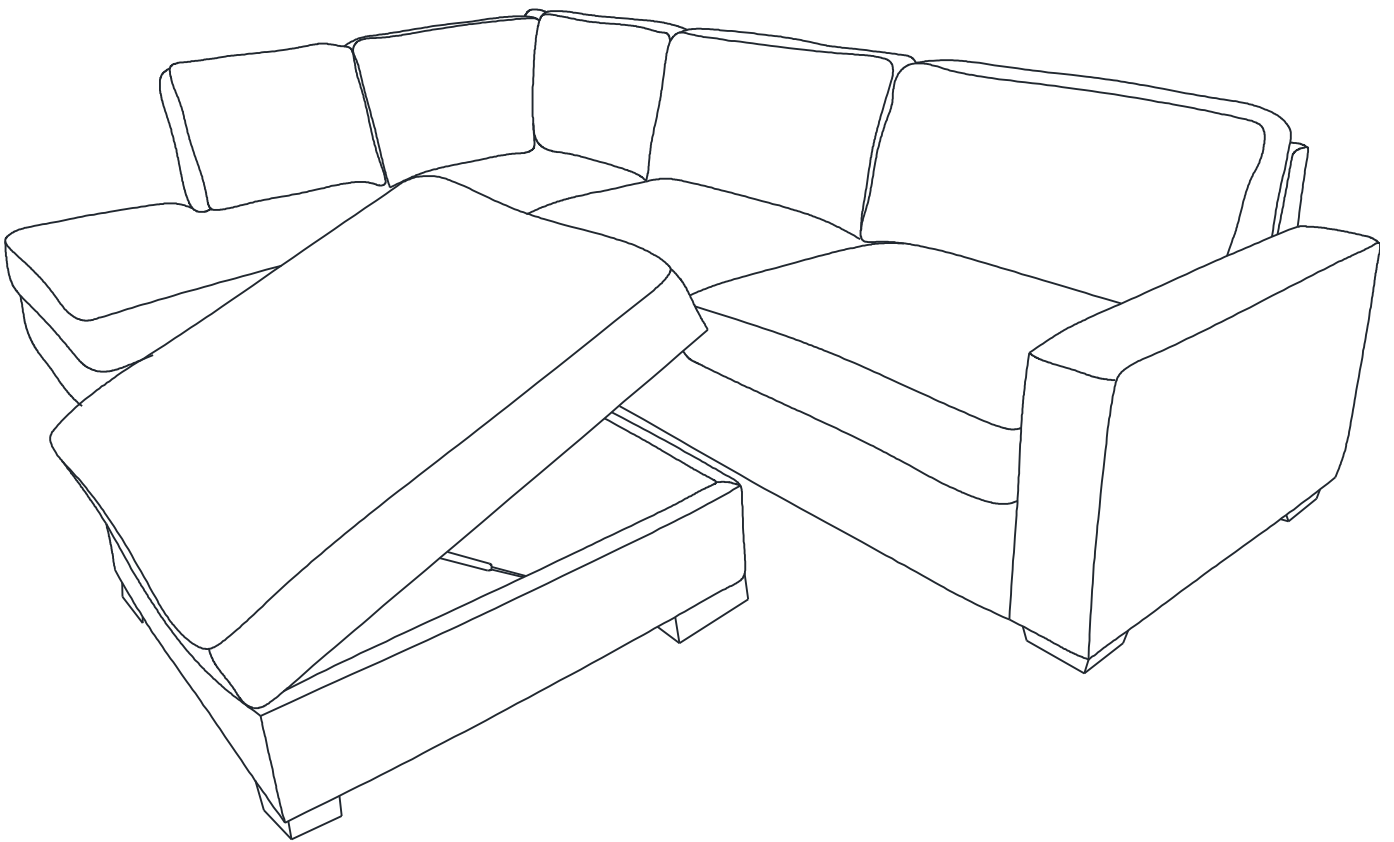
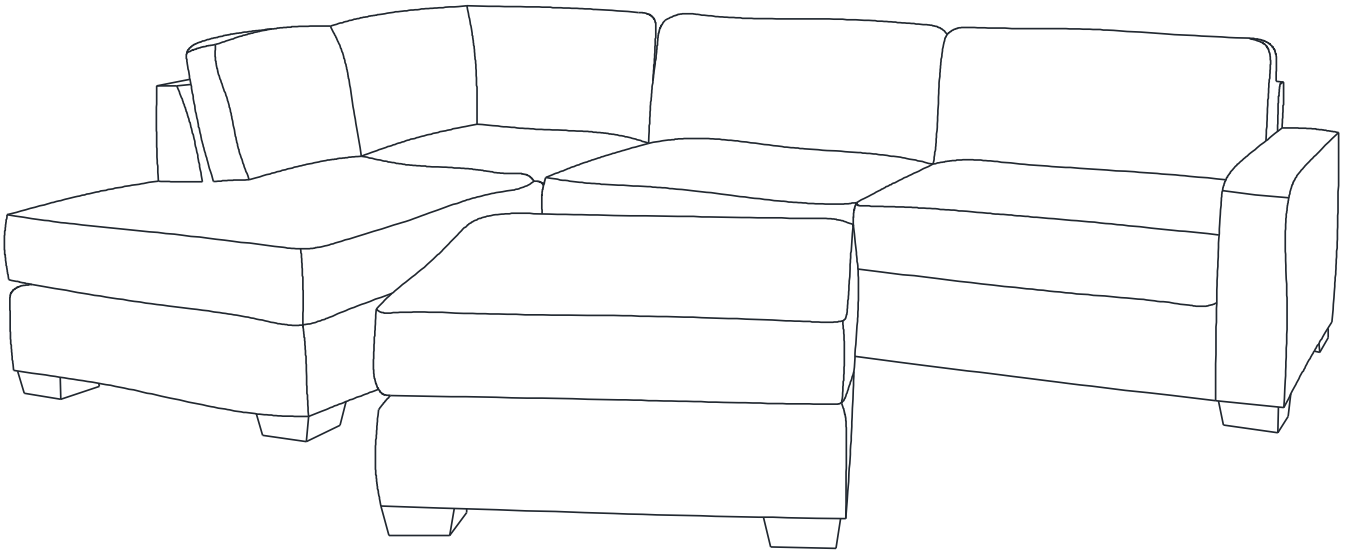

Care & Cleaning:

- Spot clean with a mild water-free solvent.
- Do not saturate with liquid.
- Pile fabrics may require brushing to restore appearance.

Entretien et nettoyage :

- Nettoyez les taches avec un solvant doux sans eau.
- Ne pas imbiber de liquide.
- Un brossage peut être nécessaire pour restaurer l'apparence des tissus duveteux.

Cuidado y limpieza:

- Mancha limpia con un solvente libre de agua suave.
- No empape.
- Para restaurar la apariencia del terciopelo, utilice una escobilla.

Distributed by:
Costco Wholesale Corporation
P.O. Box 34535
Seattle, WA 98124-1535
USA
1-800-774-2678
www.costco.com

Costco Wholesale Canada Ltd.*
415 W. Hunt Club Road
Ottawa, Ontario
K2E 1C5, Canada
1-800-463-3783
www.costco.ca
* faisant affaire au Québec sous
le nom les Entrepôts Costco

Importado por:
Importadora Primex S.A. de C.V.
Blvd. Magnocentro No. 4
San Fernando La Herradura
Huixquilucan, Estado de México
C.P. 52765
RFC: IPR-930907-S70
(55)-5246-5500
www.costco.com.mx

Costco Wholesale Australia Pty Ltd
17-21 Parramatta Road
Lidcombe NSW 2141
Australia
www.costco.com.au

Costco Wholesale Spain S.L.U.
Polígono Empresarial Los Gavilanes
C/ Agustín de Betancourt, 17
28906 Getafe (Madrid) España
NIF: B86509460
900 111 155
www.costco.es

Costco Wholesale Iceland ehf.
Kauptún 3-7, 210 Gardabaer
Iceland
www.costco.is

Costco France
1 avenue de Bréhat
91140 Villebon-sur-Yvette
France
01 80 45 01 10
www.costco.fr

Costco Wholesale Japan Ltd.
3-1-4 Ikegami-Shincho
Kawasaki-ku, Kawasaki-shi,
Kanagawa 210-0832 Japan
0570-032600
www.costco.co.jp

Costco Wholesale Korea, Ltd.
40, Iljik-ro
Gwangmyeong-si
Gyeonggi-do, 14347, Korea
1899-9900
www.costco.co.kr

Costco Wholesale New Zealand Limited
67 Maki Street
Massey, Auckland 0814
New Zealand

Shanghai Minhang Costco Trading Co., Ltd
No. 235, ZhuJian Road
Minhang District, Shanghai
China 201106
+86-21-6257-7065