

ITM. / ART. 1356738

MFR# 8B203G

Gentleman's Chest

Commode pour hommes

Cómoda para caballero



Assembly Instructions

Instructions d'assemblage

Instrucciones de ensamble

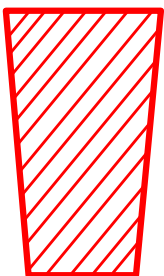

IMPORTANT, RETAIN FOR FUTURE REFERENCE: READ CAREFULLY
For more information, visit: www.northridge-home.com

IMPORTANT, À CONSERVER POUR DE FUTURS BESOINS
DE RÉFÉRENCE : À LIRE SOIGNEUSEMENT
Pour en savoir plus, visiter le www.northridge-home.com



IMPORTANTE: CONSERVE PARA FUTURA REFERENCIA. LEA
CUIDADOSAMENTE
Para más información, visite: www.northridge-home.com

For parts or customer service call: **1-866-387-8065**

Or email: info@northridge-home.com

(English, French and Spanish languages spoken)

Monday-Friday 8am - 8pm (EST).

Telephone number is only valid in the United States and Canada.

Pièces et service à la clientèle : **1-866-387-8065**

Courriel : info@northridge-home.com

(Anglais, français et espagnol)

Du lundi au vendredi : de 8 h à 20 h (HNE).

Ce numéro de téléphone n'est valide qu'aux États-Unis et au Canada.

Para solicitar piezas o hablar con un representante
de atención al cliente, llame al **1-866-387-8065**

Correo electrónico: info@northridge-home.com

(Atención en español, inglés y francés)

De lunes a viernes, de 8am - 8pm., hora del este.

El número es válido solamente en los Estados Unidos y Canadá.

Telefono no válido en Mexico.

WARNING: Small parts choking hazard

AVERTISSEMENT : Risque d'étouffement – Comprend de petites pièces

ADVERTENCIA: Piezas pequeñas. Riesgo de asfixia.

A x 1

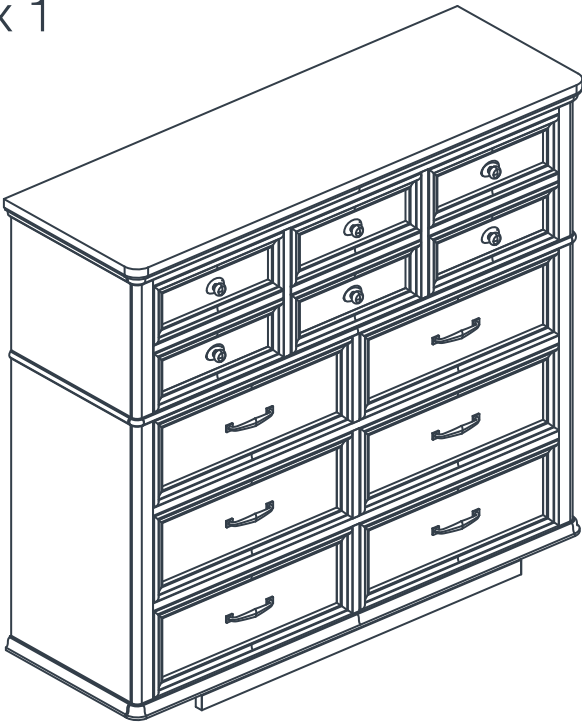

B x 1

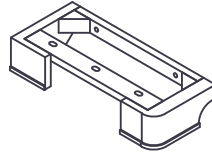

C x 1

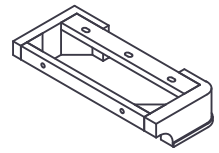

D x 1

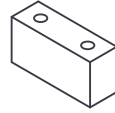

E x 12

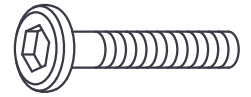

F x 12



G x 12



H x 1



I x 1

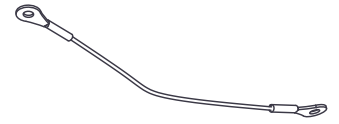

J x 2

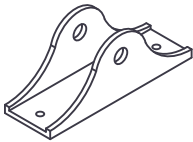

K x 2

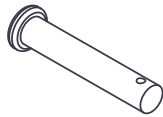

L x 2



M x 2



N x 2



Touch-up Pen
 Crayon de retouche
 Pluma para retoques



1

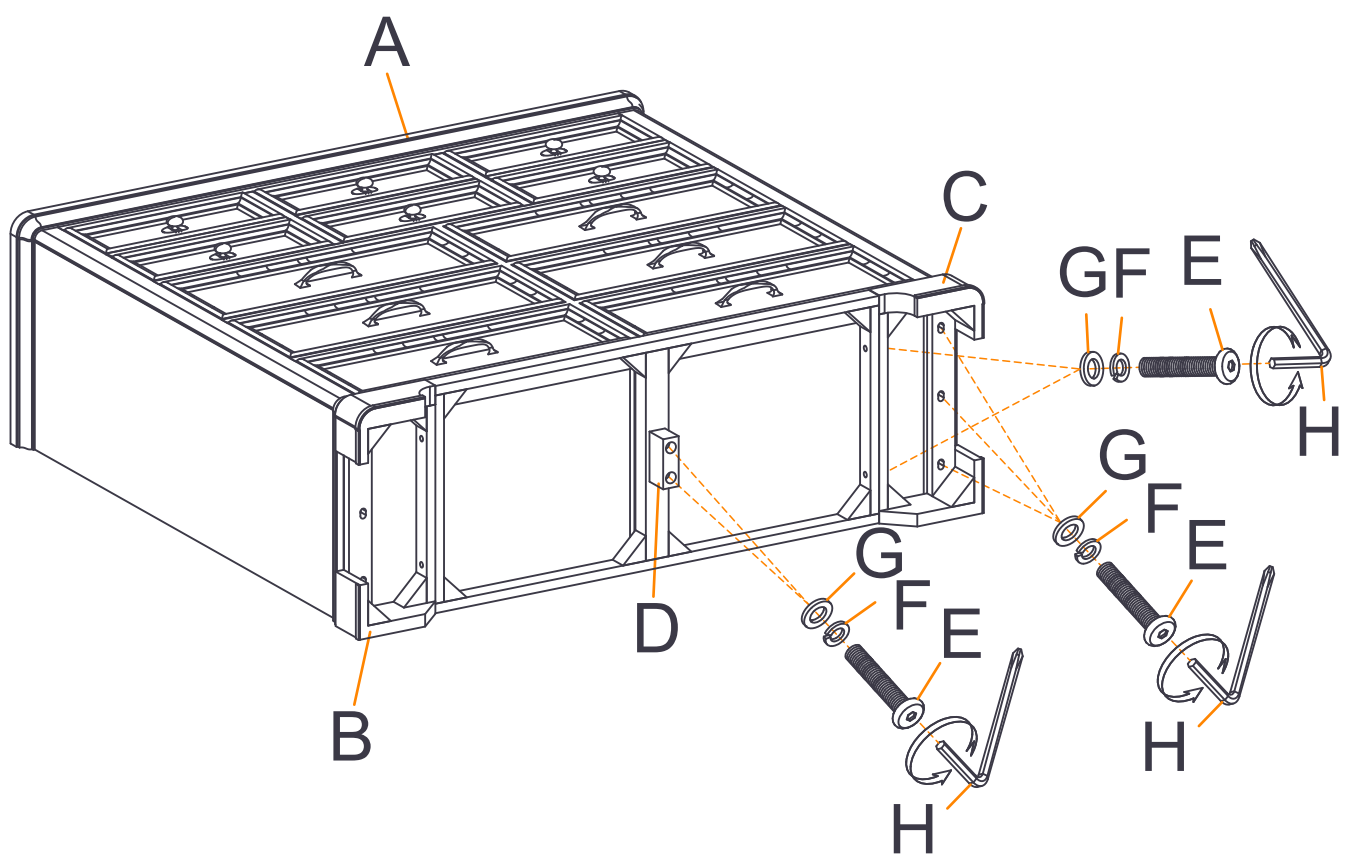

2

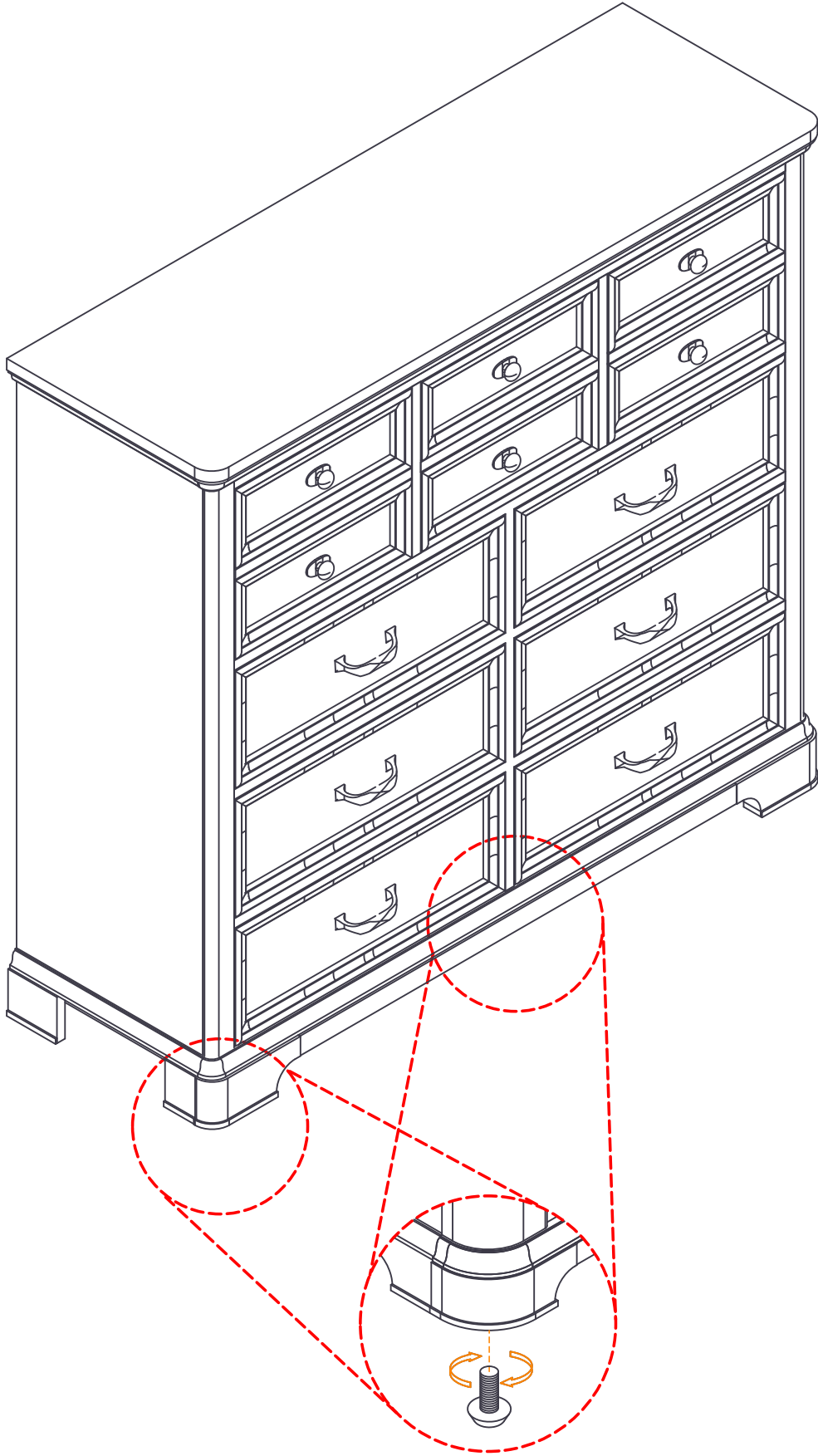

Leveler adjustment
Ajustement des patins réglables
Ajuste de los niveladores



Never mount to the edge of particle board

Ne jamais fixer sur la rive d'un panneau de particules

Nunca monte en el borde de una tabla de aglomerado.

DATE OF MANUFACTURE
DATE DE FABRICATION
FECHA DE FABRICACIÓN

Attach vertically
To wall stud

Fixer à la verticale
au montant du mur

Fije verticalmente
Al montante de pared

Attach to furniture
Solid wood only
Fixer au bois massif
du meuble seulement

Fije al mueble
Únicamente de madera sólida

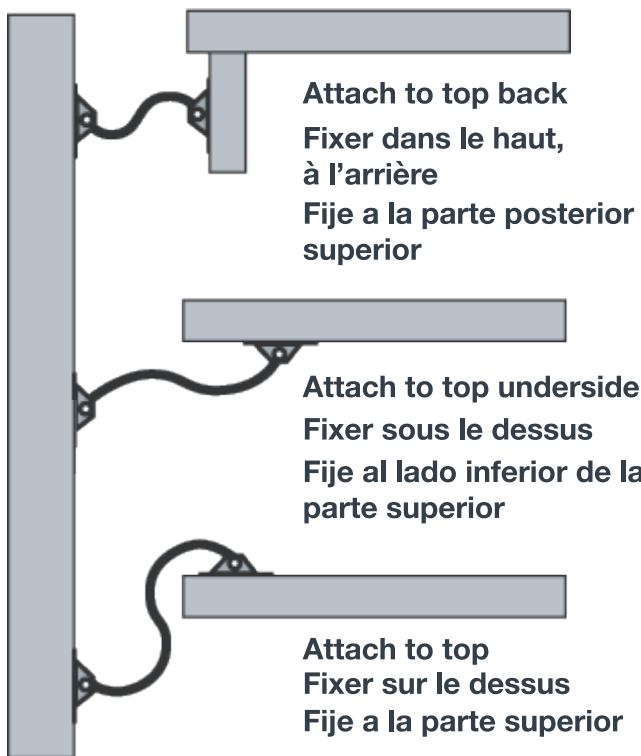
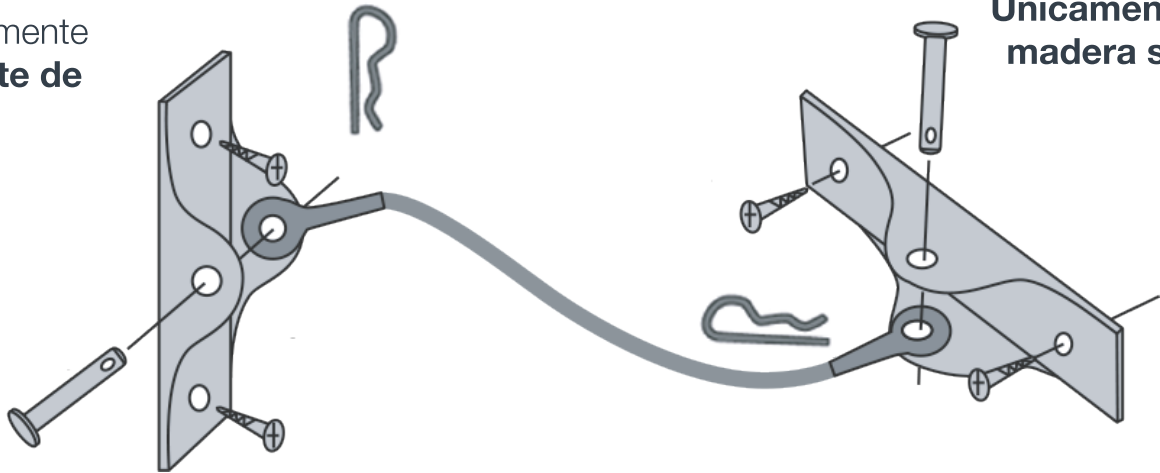

Attach to top back
Fixer dans le haut, à l'arrière
Fije a la parte posterior superior

Attach to top underside
Fixer sous le dessus
Fije al lado inferior de la parte superior

Attach to top
Fixer sur le dessus
Fije a la parte superior



Best Method

Attach to underside of top, drill through back panel

Fixation optimale

Percer le panneau arrière, y passer le dispositif et le fixer sous le dessus

Mejor método

Fije en el lado inferior de la parte superior, perfora el panel posterior

Anti-Tip Install
Installation du dispositif antibasculement
Instalación antivuelco

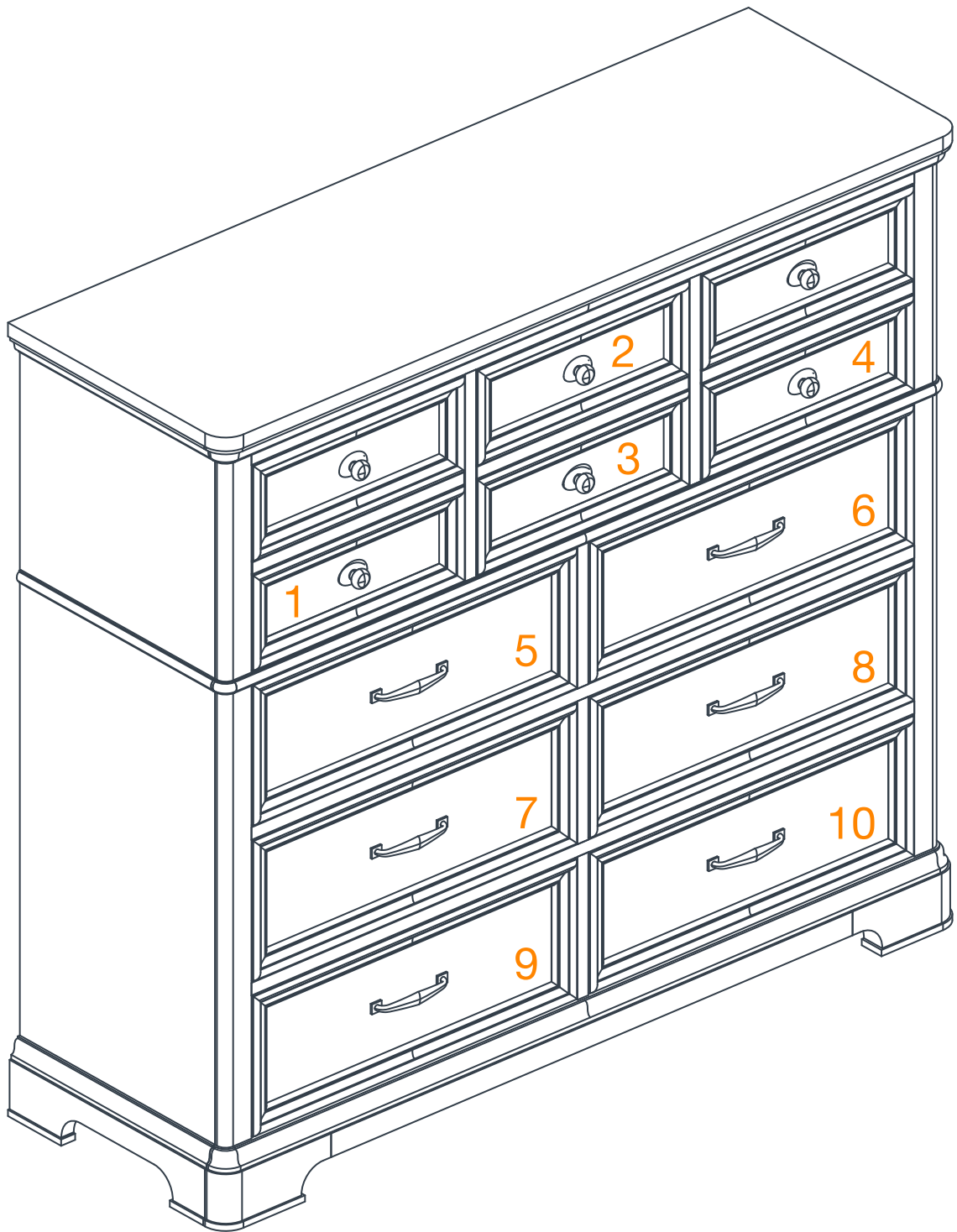

In case drawers need to be removed, each drawer is individually numbered underneath the drawer box with the corresponding number on top of the dust partition, inside the case.

S'il faut retirer les tiroirs, remarquer que chaque tiroir est numéroté. Faire correspondre le numéro situé sous le tiroir à celui sur la séparation antipoussière à l'intérieur de la commode.

En caso que sea necesario sacar los cajones, cada uno tiene un número individual. El número está escrito en el cajón y en el separador antipolvo que le corresponde dentro de la cómoda.

To install drawer:
Installation d'un tiroir :
Para instalar el cajón:

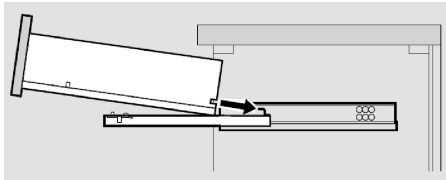
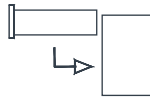

Place the drawer on the runner.
Placer le tiroir sur la glissière.
Coloque el cajón sobre la corredera.

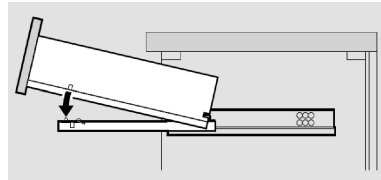

Pull forward until the peg engages with the fixing holes in the drawer base.
Tirer vers soi jusqu'à ce que la cheville s'engage dans les trous de fixation à la base du tiroir.
Tírelo hacia delante hasta que la estaca se engrana con los agujeros de fijación en la base del cajón.

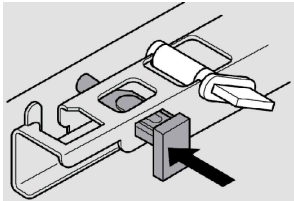

Lock the peg by pushing inside the hole in the drawer base side.
Bloquer la cheville en la poussant dans le trou, sur le côté de la base du tiroir.
Bloquee la estaca presionando dentro del agujero en el lado de la base del cajón.

To remove drawer:
Retrait d'un tiroir :
Para retirar el cajón:

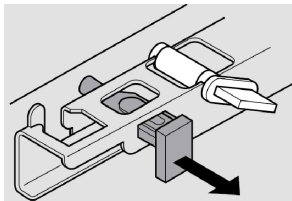

Open the lock by pushing the peg out of the hole.
Débloquer le verrou en poussant la cheville hors du trou.
Abra el bloqueo presionando la estaca fuera del agujero.

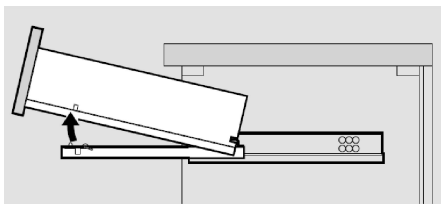

Pull the peg out of the fixing holes in the drawer base.
Tirer la cheville hors des trous de fixation à la base du tiroir.
Retire la estaca de los agujeros de fijación en la base del cajón.

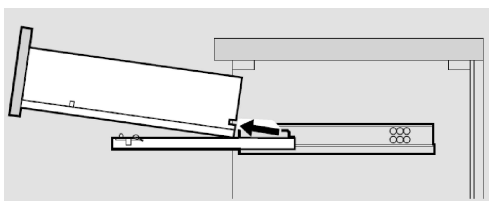

Pull all of the drawers out of the case.
Sortir tous les tiroirs du meuble.
Retire todos los cajones de la caja.

Toolless height adjustment:
Ajustement de la hauteur sans outil :
Ajuste de altura sin necesidad de herramientas:

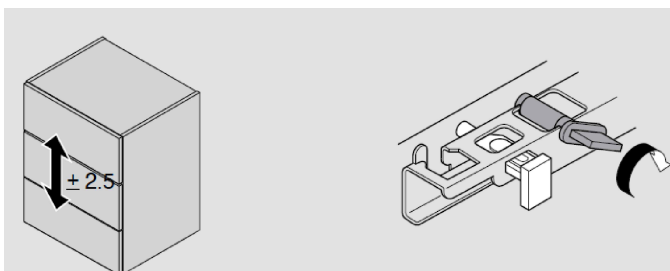

Turn the lock next to the peg from left to right.
Tourner le verrou situé à côté de la cheville de gauche à droite.
Gire el bloqueo junto a la estaca de izquierda a derecha.

 **blum**[®]

I x 1



J x 2

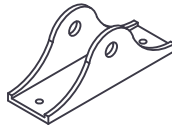

K x 2

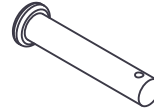

L x 2



M x 2



Patented Tip Restraint Device
Dispositif antibasculement breveté
Dispositivo antivuelco patentado

H x 1

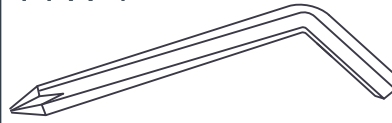

N x 2

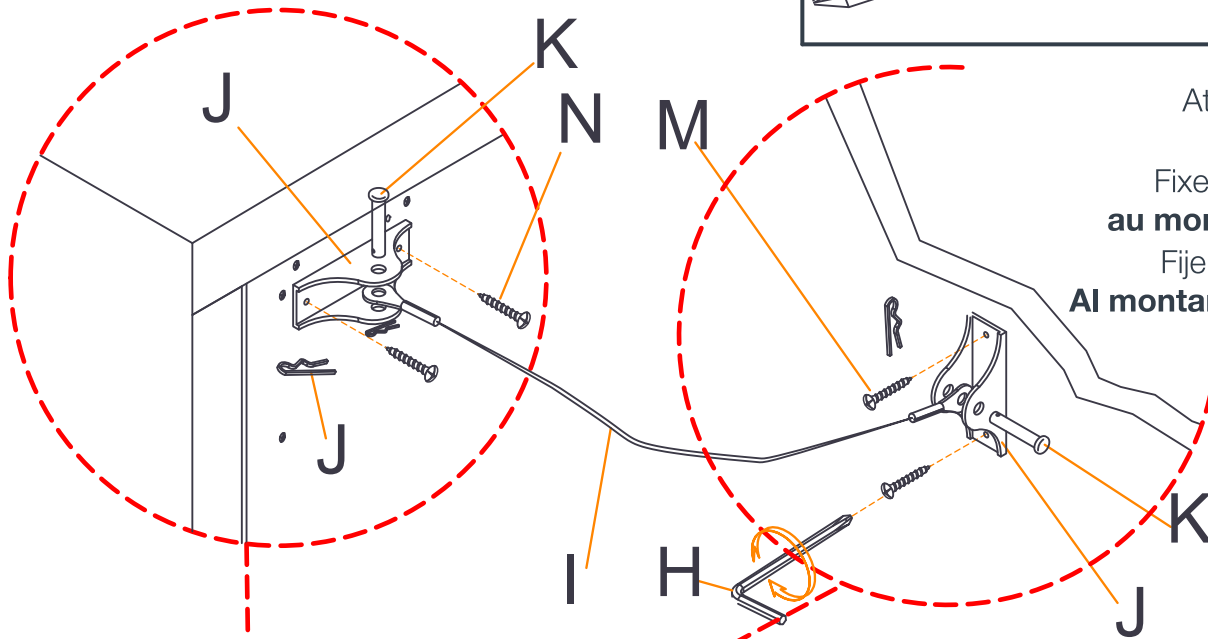

Attach vertically
To wall stud
Fixer à la verticale
au montant du mur
Fije verticalment
Al montante de pared

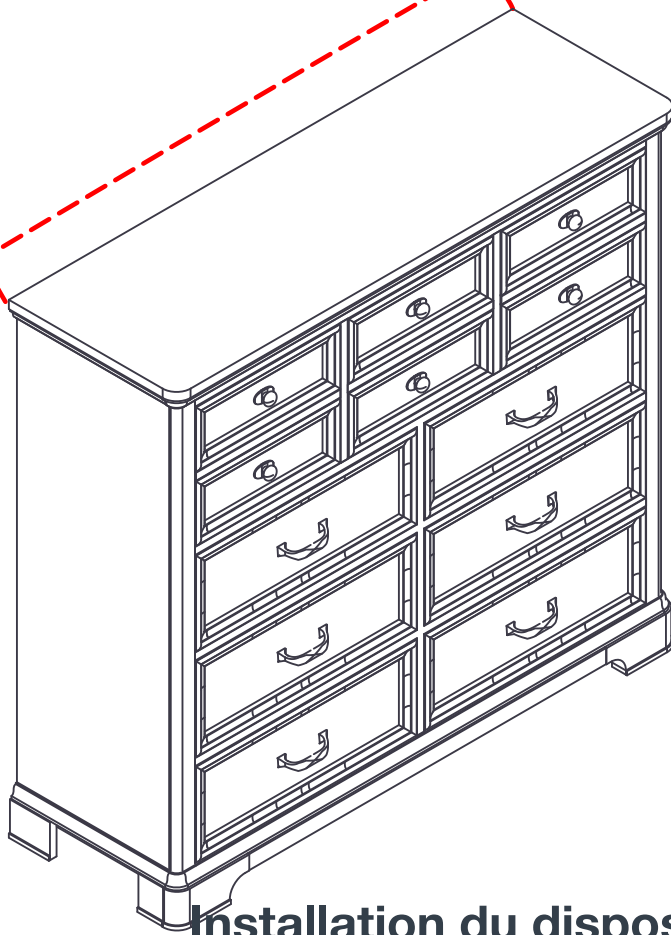

Anti-Tip Install
Installation du dispositif antibasculement
Instalación antivuelco

Care & Cleaning:

- Manufacturer recommends not to use furniture polishes or any other chemicals.
- Furniture is for indoor use only; temperature and humidity should be regulated.
- Use only soft, damp cloth for cleaning.
- Avoid direct sunlight as it can cause fading.

Entretien et nettoyage :

- Le fabricant recommande de ne pas utiliser de produit à polir ni d'autres produits chimiques.
- Ce meuble est conçu pour un usage intérieur seulement, où la température et le taux d'humidité sont contrôlés.
- Nettoyer uniquement avec un linge doux et humide.
- Éviter l'exposition directe à la lumière du soleil pour prévenir la décoloration.

Cuidado y limpieza:

- El fabricante recomienda no usar ceras para lustrar muebles o cualquier otro químico.
- Este mueble es para uso en interiores solamente. Se debe regular la temperatura y humedad.
- Utilice sólo un paño suave y húmedo para limpiar.
- Evite la luz directa del sol ya que puede causar decoloración.

Distributed by:
Costco Wholesale Corporation
P.O. Box 34535
Seattle, WA 98124-1535
USA
1-800-774-2678
www.costco.com

Costco Wholesale Canada Ltd.*
415 W. Hunt Club Road
Ottawa, Ontario
K2E 1C5, Canada
1-800-463-3783
www.costco.ca
* faisant affaire au Québec sous
le nom les Entrepôts Costco

Importado por:
Importadora Primex S.A. de C.V.
Blvd. Magnocentro No. 4
San Fernando La Herradura
Huixquilucan, Estado de México
C.P. 52765
RFC: IPR-930907-S70
(55)-5246-5500
www.costco.com.mx

Costco Wholesale Australia Pty Ltd
17-21 Parramatta Road
Lidcombe NSW 2141
Australia
www.costco.com.au

Costco Wholesale UK Ltd /
Costco Online UK Ltd
Hartspring Lane
Watford, Herts
WD25 8JS
United Kingdom
01923 213113
www.costco.co.uk

Costco Wholesale Spain S.L.U.
Polígono Empresarial Los Gavilanes
C/ Agustín de Betancourt, 17
28906 Getafe (Madrid) España
NIF: B86509460
900 111 155
www.costco.es

Costco Wholesale Iceland ehf.
Kauptún 3-7, 210 Gardabaer
Iceland
www.costco.is

Costco France
1 avenue de Bréhat
91140 Villebon-sur-Yvette
France
01 80 45 01 10
www.costco.fr

Costco Wholesale Japan Ltd.
3-1-4 Ikegami-Shincho
Kawasaki-ku, Kawasaki-shi,
Kanagawa 210-0832 Japan
0570-032600
www.costco.co.jp

Costco Wholesale Korea, Ltd.
40, Iljik-ro
Gwangmyeong-si
Gyeonggi-do, 14347, Korea
1899-9900
www.costco.co.kr

Costco Wholesale New Zealand Limited
67 Maki Street
Massey, Auckland 0814
New Zealand

Shanghai Minhong Costco Trading Co., Ltd
No. 235, ZhuJian Road
Minhang District, Shanghai
China 201106
+86-21-6257-7065